

# Notice for TAIYO YUDEN products

Please read this notice before using the TAIYO YUDEN products.



## REMINDERS

- Product information in this catalog is as of October 2008. All of the contents specified herein are subject to change without notice due to technical improvements, etc. Therefore, please check for the latest information carefully before practical application or usage of the Products.

Please note that Taiyo Yuden Co., Ltd. shall not be responsible for any defects in products or equipment incorporating such products, which are caused under the conditions other than those specified in this catalog or individual specification.

- Please contact Taiyo Yuden Co., Ltd. for further details of product specifications as the individual specification is available.
- Please conduct validation and verification of products in actual condition of mounting and operating environment before commercial shipment of the equipment.
- All electronic components or functional modules listed in this catalog are developed, designed and intended for use in general electronics equipment.(for AV, office automation, household, office supply, information service, telecommunications, (such as mobile phone or PC) etc.). Before incorporating the components or devices into any equipment in the field such as transportation,( automotive control, train control, ship control), transportation signal, disaster prevention, medical, public information network (telephone exchange, base station) etc. which may have direct influence to harm or injure a human body, please contact Taiyo Yuden Co., Ltd. for more detail in advance.

Do not incorporate the products into any equipment in fields such as aerospace, aviation, nuclear control, submarine system, military, etc. where higher safety and reliability are especially required.

In addition, even electronic components or functional modules that are used for the general electronic equipment, if the equipment or the electric circuit require high safety or reliability function or performances, a sufficient reliability evaluation check for safety shall be performed before commercial shipment and moreover, due consideration to install a protective circuit is strongly recommended at customer's design stage.

- The contents of this catalog are applicable to the products which are purchased from our sales offices or distributors (so called "TAIYO YUDEN' s official sales channel"). It is only applicable to the products purchased from any of TAIYO YUDEN' s official sales channel.
- Please note that Taiyo Yuden Co., Ltd. shall have no responsibility for any controversies or disputes that may occur in connection with a third party's intellectual property rights and other related rights arising from your usage of products in this catalog. Taiyo Yuden Co., Ltd. grants no license for such rights.
- Caution for export  
Certain items in this catalog may require specific procedures for export according to "Foreign Exchange and Foreign Trade Control Law" of Japan, "U.S. Export Administration Regulations," and other applicable regulations. Should you have any question or inquiry on this matter, please contact our sales staff.  
Should you have any question or inquiry on this matter, please contact our sales staff.

# コモンモードチョークコイル (DC、信号ライン用) SMDタイプ

## COMMON MODE CHOKE COILS (FOR DC AND SIGNAL LINES) SMD TYPE



リフロー/REFLOW

OPERATING TEMP.	-25~+105°C (製品自己発熱を含む) (Including self-generated heat)				
等価回路 Equivalent circuits	CM04RC (2 Lines) Type	CM04RC (3 Lines) Type	CM04RC (4 Lines) Type	BU05MC (2 Lines) Type	BU05MC (3 Lines) Type

### 特長 FEATURES

- SMT対応
- 高結合なコイル構造によりコモンモードノイズの除去に最適
- Available in embossed tape and reel.
- Highly coupled coil construction ideal for common mode noise attenuation

### 用途 APPLICATIONS

- 多機能電話機, PBX, FAXなど外線の不要輻射電界および放送波に対するイミュニティ対策
- 各種電子機器のDCラインのノイズ対策
- ACアダプタ、バッテリーチャージャー及び各種デジタル機器の電源2次側ライン、信号ラインの不要輻射対策
- DVC, DSC等の電源、2次側DCラインの不要輻射対策。
- パーソナルコンピューター、プリンター、スキャナー等のUSB(D+, D-)及びIEEE1394の高速差動伝送のノイズ除去。
- Immunity against undesirable external line radiation fields and broadcast waves generated by multifunction telephone sets, PBXs, and facsimile machines.
- Preventive measure against DC line noise in electronic equipment.
- Suppresses radiated emissions from secondary power supplies and signal lines on AC adapters, battery chargers, and digital equipment.
- Excellent for reducing radiated noise in DVC (digital video cameras) and DSC (digital still cameras)
- Offers high speed differential mode noise attenuation in USB and IEEE1394 connectors in personal computers, printers, scanners and other computer peripherals

### 形名表記法 ORDERING CODE

<b>1</b> 形式 CM BU	コモンモードチョークコイル	<b>3</b> 形状 RC MC	面実装タイプ	<b>4</b> 試作番号 01~10	<b>5</b> 包装記号 T	テーピング品
<b>2</b> コアの長辺寸法 (mm) 04 05	3.5 5.0	<b>6</b> 当社管理番号 △	標準品	△=スペース		



<b>1</b> Type CM BU	Common mode choke coils	<b>3</b> Shape RC MC	Surface mount type	<b>4</b> Product classification code 01~10	<b>5</b> Packaging T	Taped products
<b>2</b> Dimensions of Core (mm) 04 05	3.5 5.0	<b>6</b> Internal code △	Standard Products	△=Blank space		

# 外形寸法 EXTERNAL DIMENSIONS

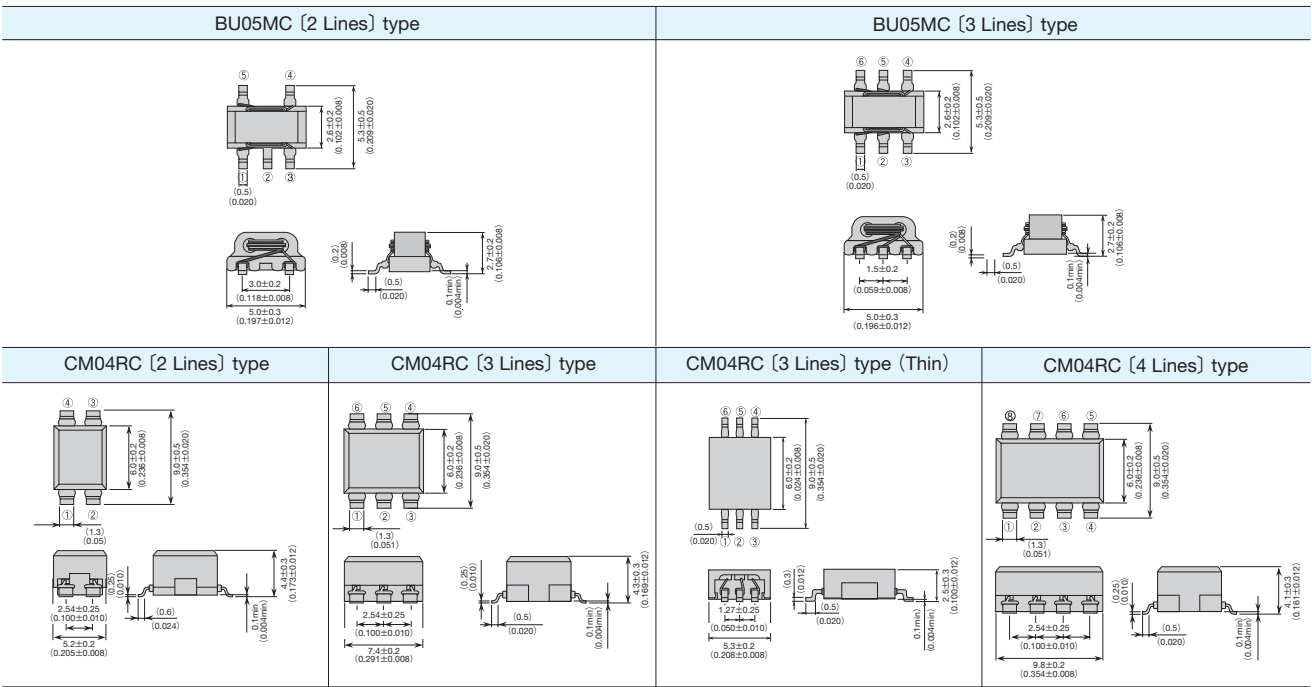

公差のない数値は参考値です。 The values without tolerance are for reference only.

Unit : mm (inch)

# アイテム一覧 PART NUMBERS

## CM04RCタイプ

形名 Ordering code	EHS (Environmental Hazardous Substances)	ライン数 No. of Lines	インピーダンス Impedance [Ω] (typical)	直流抵抗 DC resistance [Ω] (max.)	定格電流 Rated current [A] (max.)	定格電圧 Rated voltage [V] (D.C.)	絶縁抵抗 Insulation resistance [MΩ] (min.)
CM04RC01T	RoHS	2	800 (at 100MHz)	0.06	1.5	50	100
CM04RC04T	RoHS		900 (at 20MHz)	0.1	1.3		
CM04RC07T	RoHS		500 (at 160MHz)	0.06	2.5		
CM04RC09T	RoHS		270 (at 200MHz)	0.03	3.0		
CM04RC10T	RoHS		100 (at 200MHz)	0.02	4.0		
CM04RC02T	RoHS	3	1000 (at 100MHz)	0.18	0.5	50	100
CM04RC08T (THIN)	RoHS		1000 (at 200MHz)	0.2	0.5		
CM04RC05T	RoHS	4	800 (at 100MHz)	0.2	0.5	50	100

## BU05MCタイプ

形名 Ordering code	EHS (Environmental Hazardous Substances)	ライン数 No. of Lines	インピーダンス Impedance [Ω] (typical)	直流抵抗 DC resistance [Ω] (max.)	定格電流 Rated current [A] (max.)	定格電圧 Rated voltage [V] (D.C.)	絶縁抵抗 Insulation resistance [MΩ] (min.)
BU05MC01T	RoHS	2	1000 (at 60MHz)	0.12	1	50	100
BU05MC08T	RoHS	3	700 (at 60MHz)	0.11	0.5		

セクションガイド  
Selection Guide

アイテム一覧  
Part Numbers

特性図  
Electrical Characteristics

梱包  
Packaging

信頼性  
Reliability Data

使用上の注意  
Precautions



etc

△当社カタログをご使用の際には「当社製品に関するお断り」を必ずお読みください。

TAIYO YUDEN 2009

△Please read the "Notice for TAIYO YUDEN products" before using this catalog.

インピーダンス周波数特性例 Impedance -vs- Frequency characteristics (Measured by HP4291A)

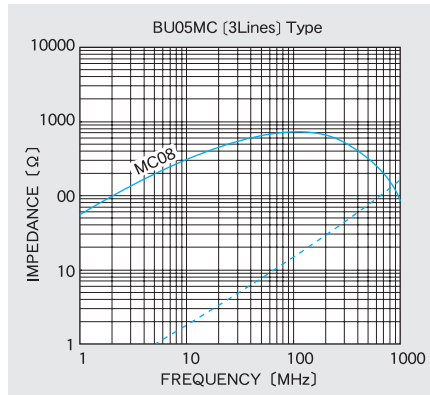
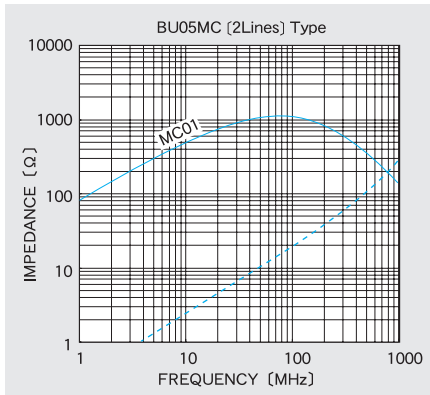
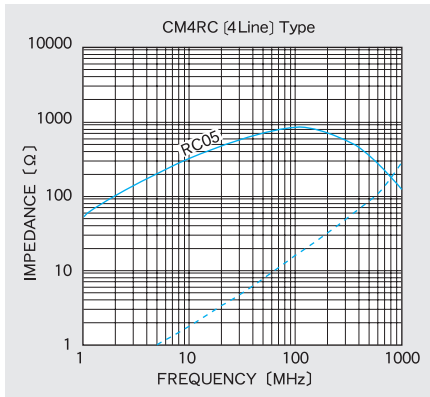
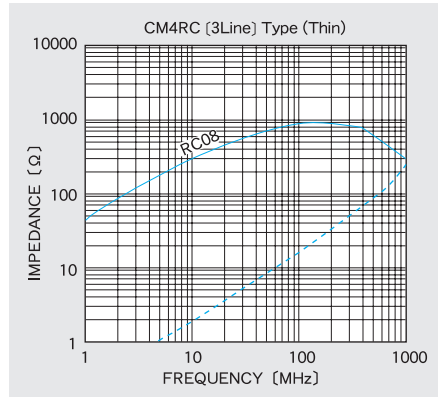
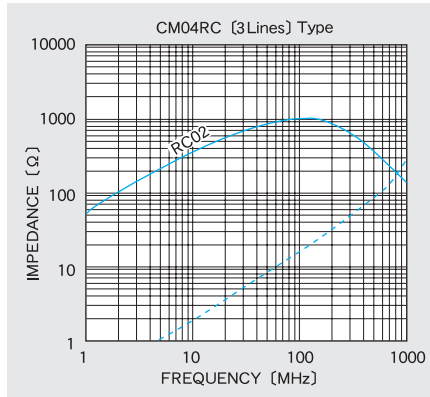
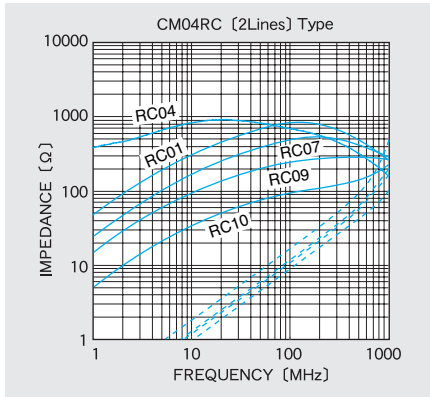

— コモンモード  
Common mode  
- - - ノーマルモード  
Normal mode

①最小受注単位数 Minimum Quantity

Type	最小受注単位数 (pcs.) Minimum Quantity
	エンボステープ Embossed tape
CM01H [2 Lines] type	3000
CM04RC [2 Lines] type	1500
CM04RC [3 Lines] type	1000
CM04RC [3 Lines] type (Thin)	2500
CM04RC [4 Lines] type	1000
BU05MC [2 Lines] type	2500
BU05MC [3 Lines] type	2500

②テーピング材質 Tape Material

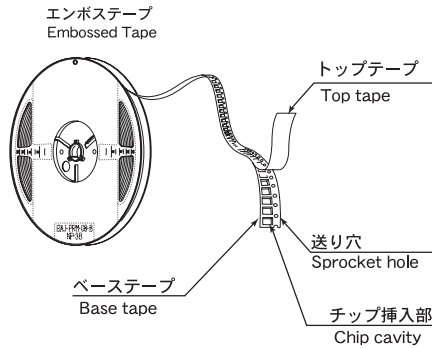

③リーダー部・空部 Leader and Blank Portion

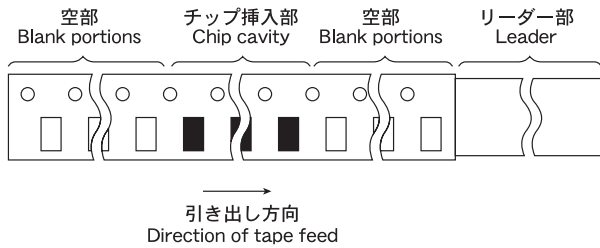

Type	リーダー部 Leader	空部 (リーダー部側) Blank portions (Leader side)	空部 (チップ挿入部側) Blank portions (Chip cavity side)
CM01H	200~400 (7.87~15.75)	160~200 (6.30~7.87)	160 (6.30) 以上
CM04RC	150 (5.89)	80 (3.14)	80 (3.14)
BU05MC	150 (5.89)	80 (3.14)	80 (3.14)

Unit : mm (inch)

④リール寸法 Reel size

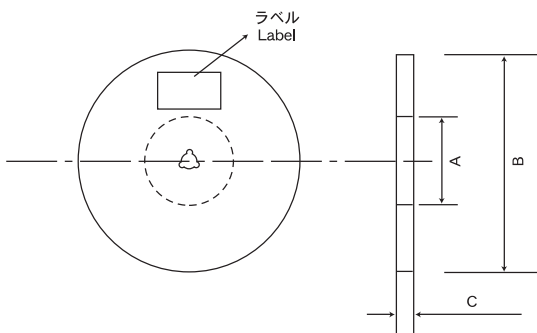

Type	A	B	C
CM01H	$\phi 60+1/-0$ ( $\phi 2.36+0.039/-0$ )	$\phi 180+0/-3$ ( $\phi 7.09+0/-0.118$ )	$10.0\pm 1.5$ ( $0.394\pm 0.059$ )
CM04RC	$\phi 100\pm 1$ ( $\phi 3.94\pm 0.039$ )	$\phi 330\pm 2$ ( $\phi 12.99\pm 0.079$ )	$18\pm 1.5$ ( $0.709\pm 0.059$ )
BU05MC	$\phi 80\pm 1$ ( $\phi 3.15\pm 0.039$ )	$\phi 330\pm 2$ ( $\phi 12.99\pm 0.079$ )	$13.5\pm 1$ ( $0.53\pm 0.039$ )

Unit : mm (inch)

エンボステープ (CM01Hタイプ) Embossed tape (CM01H type)

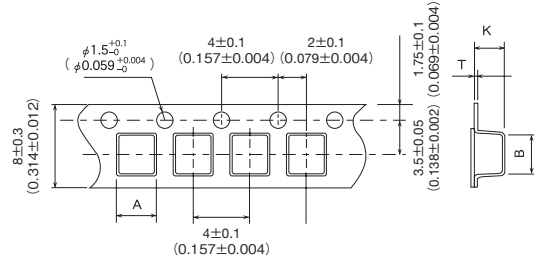

エンボステープ (CM04RCタイプ) Embossed tape (CM04RC type)  
(1) 8mm pitch (0.31 inches pitch)

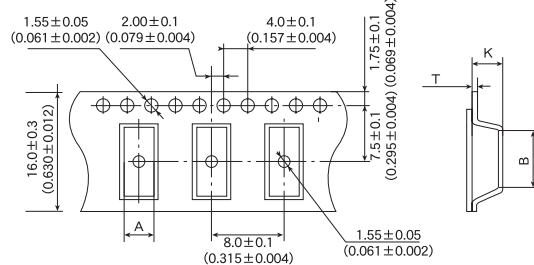

(2) 12mm pitch (0.472 inches pitch)

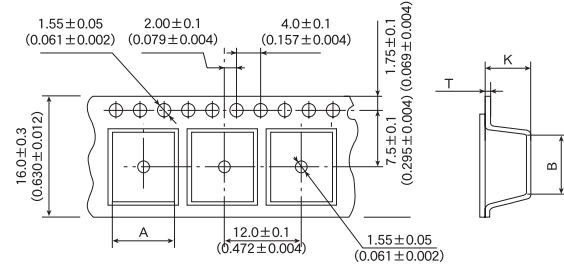

エンボステープ (BU05MCタイプ) Embossed tape (BU05MC type)

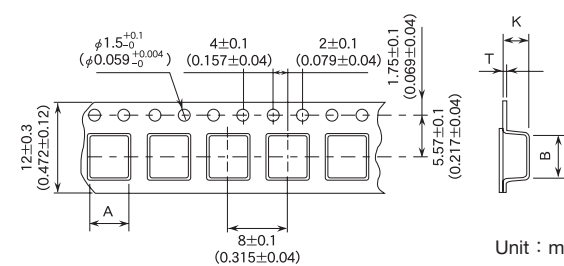

Unit : mm (inch)

Type	ライン数 Lines	挿入ピッチ Insertion pitch	チップ挿入部 Chip cavity		テープ厚み Tape thickness	
			A	B	K	T
CM01H	2	4.0±0.1	1.16±0.1	1.41±0.1	0.98±0.1	0.3max.
	2	8.0±0.1	5.7±0.1	9.65±0.1	5.2max	0.4±0.05
CM04RC	3	12.0±0.1	9.8±0.1	7.7±0.1	5.0max	0.38±0.05
	3 (THIN)	8.0±0.1	5.7±0.1	9.8±0.1	3.1max	0.4±0.05
BU05MC	4	12.0±0.1	10.3±0.1	10.3±0.1	5.0max	0.3±0.05
	2	8.0±0.1	5.35±1.5	5.7±0.2	3.2±0.1	0.4±0.05
	3					

Unit : mm

⑥トップテープ強度 Top Tape Strength

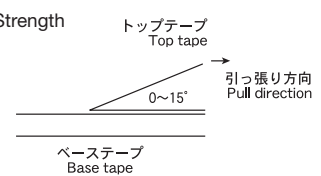

●CM01H

トップテープのはがし力は、下図矢印方向にて0.1~1.0Nとなります。  
The top tape requires a peel-off force of 0.1 to 1.0N in the direction of the arrow as illustrated below.

●CM04RC・BU05MC

トップテープのはがし力は、下図矢印方向にて0.1~0.7Nとなります。  
The top tape requires a peel-off force of 0.1 to 0.7N in the direction of the arrow as illustrated below.

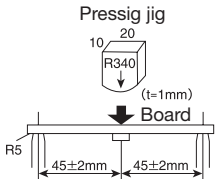
Item	Specified Value			Test Method and Remarks												
	CommonMode Choke Coils CM01H	CommonMode Choke Coils CM04RC	CommonMode Choke Coils BU05MC													
1.Operating Temperature Range	-40°C~+105°C	-25°C~+105°C		Including self-generated heat												
2.Storage Temperature Range	-40°C~+85°C	-40°C~+85°C		-5 to +40°C in taped packaging												
3.Rated current	Within the specified tolerance.			The maximum DC value having temperature increase within specified temperature, as detailed in individual specification.												
4.Impedance	Within the specified tolerance.			Measuring equipment : HP 4291A or its equivalent Measuring frequency : Specified frequency												
5.Inductance	—	Within the specified tolerance.														
6.DC Resisitance	Within the specified tolerance.			SMD transformer · Commom mode choke coil : Measuring equipment : DC ohm meter												
7.Resistance to flexure of substrate	Within the specified tolerance.	Refer to individual specification.		According to JIS C0051  <table border="1"> <thead> <tr> <th></th> <th>CM01H</th> <th>CM04RC·BU05MC</th> </tr> </thead> <tbody> <tr> <td>Warp</td> <td>2mm</td> <td>3mm</td> </tr> <tr> <td>Pressing speed</td> <td colspan="2">0.5mm/sec.</td> </tr> <tr> <td>Duration</td> <td colspan="2">5±1sec.</td> </tr> </tbody> </table> 		CM01H	CM04RC·BU05MC	Warp	2mm	3mm	Pressing speed	0.5mm/sec.		Duration	5±1sec.	
	CM01H	CM04RC·BU05MC														
Warp	2mm	3mm														
Pressing speed	0.5mm/sec.															
Duration	5±1sec.															
8.Dielectric resistance : between wires	100MΩ min.			Applied voltage : Rated voltage Duration : 60 sec.												
9.Rated voltage	Within the specification.															
10.Withstanding voltage : between wires	No abnormality.			Applied voltage : Regulation voltage Duration : 60 sec.												
11.Resistance to vibration	No abnormality observed in appearance	Refer to individual specification.		According to JIS C0040 Directions : 2 hrs each in X, Y, and Z directions. Total : 6 hrs Frequency range : 10 to 55 to 10 Hz (1 min.) Amplitude : 1.5mm (Shall not exceed acceleration 196m/s <sup>2</sup> ) Mounting method : soldering onto printed board Recovery : At least 2 hrs of recovery under the standard condition after the test, followed by the measurement within 48 hrs.												
12.Solderability	At least 90% of terminal electrode is covered by new solder.	At least 75% of terminal electrode is covered by new solder.		<table border="1"> <thead> <tr> <th></th> <th>CM01H</th> <th>CM04RC·BU05MC</th> </tr> </thead> <tbody> <tr> <td>Solder temperature</td> <td>245±5°C</td> <td>235±5°C</td> </tr> <tr> <td>Duration</td> <td>3±1sec.</td> <td>2±0.5sec.</td> </tr> <tr> <td>Immersion depth</td> <td>—</td> <td>Up to 0.5mm from terminal root</td> </tr> </tbody> </table>		CM01H	CM04RC·BU05MC	Solder temperature	245±5°C	235±5°C	Duration	3±1sec.	2±0.5sec.	Immersion depth	—	Up to 0.5mm from terminal root
	CM01H	CM04RC·BU05MC														
Solder temperature	245±5°C	235±5°C														
Duration	3±1sec.	2±0.5sec.														
Immersion depth	—	Up to 0.5mm from terminal root														
13.Resistance to solder Heat	Within the specified tolerance.	Refer to individual specification.		<table border="1"> <thead> <tr> <th></th> <th>CM01H</th> <th>CM04RC·BU05MC</th> </tr> </thead> <tbody> <tr> <td>Reflow soldering</td> <td>Preheating: 150to180°C 1to2min Peak: 255±5°C 5sec More than 230°C within 40 sec Number of reflow: Within 2 times</td> <td>Preheating: 100to150°C 1to2min Peak: 230 to 240°C within 5sec More than 200°C within 40sec Number of reflow: Within 2 times</td> </tr> <tr> <td>Manual soldering</td> <td>—</td> <td>Solder temperature: 350±5°C Duration: 3±1sec Recovery: 1to2hrs of recovery under the standard condition after the test.</td> </tr> </tbody> </table>		CM01H	CM04RC·BU05MC	Reflow soldering	Preheating: 150to180°C 1to2min Peak: 255±5°C 5sec More than 230°C within 40 sec Number of reflow: Within 2 times	Preheating: 100to150°C 1to2min Peak: 230 to 240°C within 5sec More than 200°C within 40sec Number of reflow: Within 2 times	Manual soldering	—	Solder temperature: 350±5°C Duration: 3±1sec Recovery: 1to2hrs of recovery under the standard condition after the test.			
	CM01H	CM04RC·BU05MC														
Reflow soldering	Preheating: 150to180°C 1to2min Peak: 255±5°C 5sec More than 230°C within 40 sec Number of reflow: Within 2 times	Preheating: 100to150°C 1to2min Peak: 230 to 240°C within 5sec More than 200°C within 40sec Number of reflow: Within 2 times														
Manual soldering	—	Solder temperature: 350±5°C Duration: 3±1sec Recovery: 1to2hrs of recovery under the standard condition after the test.														

Item	Specified Value			Test Method and Remarks																							
	CommonMode Choke Coils CM01H	CommonMode Choke Coils CM04RC	CommonMode Choke Coils BU05MC																								
14.Thermal shock	Within the specified tolerance.	Refer to individual specification.		According to JIS C0025 Conditions of 1 cycle <table border="1"> <thead> <tr> <th rowspan="2">Step</th> <th colspan="2">Temperature (°C)</th> <th>Time (min)</th> </tr> <tr> <th>CM01H</th> <th>CM04RC·BU05MC</th> <th>CM01H / CM04RC·BU05MC</th> </tr> </thead> <tbody> <tr> <td>1</td> <td>-40±3°C</td> <td>-25±3°C</td> <td>30±3</td> </tr> <tr> <td>2</td> <td>Room Temp.</td> <td>Room Temp.</td> <td>3</td> </tr> <tr> <td>3</td> <td>85±2°C</td> <td>85±3°C</td> <td>30±3</td> </tr> <tr> <td>4</td> <td>Room Temp.</td> <td>Room Temp.</td> <td>3</td> </tr> </tbody> </table> Number of cycle : CM01H : 100 cycle CM04RC · BU05MC : 10 cycle Recovery : Recovery under the standard condition after removal from test chamber. CM01H : Measuring it more than two hours and less than 48 hours. CM04RC · BU05MC : Leave during 1~2 hour.	Step	Temperature (°C)		Time (min)	CM01H	CM04RC·BU05MC	CM01H / CM04RC·BU05MC	1	-40±3°C	-25±3°C	30±3	2	Room Temp.	Room Temp.	3	3	85±2°C	85±3°C	30±3	4	Room Temp.	Room Temp.	3
Step	Temperature (°C)		Time (min)																								
	CM01H	CM04RC·BU05MC	CM01H / CM04RC·BU05MC																								
1	-40±3°C	-25±3°C	30±3																								
2	Room Temp.	Room Temp.	3																								
3	85±2°C	85±3°C	30±3																								
4	Room Temp.	Room Temp.	3																								
15.Loading under damp heat	Within the specified tolerance.	Refer to individual specification.		<table border="1"> <thead> <tr> <th></th> <th>CM01H</th> <th>CM04RC·BU05MC</th> </tr> </thead> <tbody> <tr> <td>Temperature</td> <td>60±2°C</td> <td>40±3°C</td> </tr> <tr> <td>Humidity</td> <td colspan="2">90~95%RH</td> </tr> <tr> <td>Applied current</td> <td colspan="2">Rated current</td> </tr> <tr> <td>Duration</td> <td colspan="2">1000±24hrs</td> </tr> </tbody> </table> Recovery : Recovery under the standard condition after removal from test chamber. CM01H : Measuring it more than two hours and less than 48 hours. CM04RC · BU05MC : Leave during 1~2 hour.		CM01H	CM04RC·BU05MC	Temperature	60±2°C	40±3°C	Humidity	90~95%RH		Applied current	Rated current		Duration	1000±24hrs									
	CM01H	CM04RC·BU05MC																									
Temperature	60±2°C	40±3°C																									
Humidity	90~95%RH																										
Applied current	Rated current																										
Duration	1000±24hrs																										
16.High temperature life test	-	Refer to individual specification.		<table border="1"> <thead> <tr> <th></th> <th>CM04RC·BU05MC</th> </tr> </thead> <tbody> <tr> <td>Temperature</td> <td>85±3°C</td> </tr> <tr> <td>Duration</td> <td>1000±24hrs</td> </tr> </tbody> </table> Recovery : Recovery under the standard condition after removal from test chamber. CM01H : Measuring it more than two hours and less than 48 hours. CM04RC · BU05MC : Leave during 1~2 hour.		CM04RC·BU05MC	Temperature	85±3°C	Duration	1000±24hrs																	
	CM04RC·BU05MC																										
Temperature	85±3°C																										
Duration	1000±24hrs																										
17.Low Temperature life Test	Within the specified tolerance.	Refer to individual specification.		<table border="1"> <thead> <tr> <th></th> <th>CM01H</th> <th>CM04RC·BU05MC</th> </tr> </thead> <tbody> <tr> <td>Temperature</td> <td>-40±2°C</td> <td>-40±3°C</td> </tr> <tr> <td>Applied current</td> <td colspan="2">1000±24hrs</td> </tr> </tbody> </table> Recovery : Recovery under the standard condition after removal from test chamber. CM01H : Measuring it more than two hours and less than 48 hours. CM04RC · BU05MC : Leave during 1~2 hour.		CM01H	CM04RC·BU05MC	Temperature	-40±2°C	-40±3°C	Applied current	1000±24hrs															
	CM01H	CM04RC·BU05MC																									
Temperature	-40±2°C	-40±3°C																									
Applied current	1000±24hrs																										
18.Loading at high temperature life test	Within the specified tolerance.	-		<table border="1"> <thead> <tr> <th></th> <th>CM01H</th> </tr> </thead> <tbody> <tr> <td>Temperature</td> <td>105±2°C</td> </tr> <tr> <td>Applied current</td> <td>Rated current</td> </tr> <tr> <td>Duration</td> <td>1000±24hrs</td> </tr> </tbody> </table> Recovery : Recovery under the standard condition after removal from test chamber. CM01H : Measuring it more than two hours and less than 48 hours. CM04RC · BU05MC : Leave during 1~2 hour.		CM01H	Temperature	105±2°C	Applied current	Rated current	Duration	1000±24hrs															
	CM01H																										
Temperature	105±2°C																										
Applied current	Rated current																										
Duration	1000±24hrs																										

Note on standard condition: "standard condition" referred to herein is defined as follows:

5 to 35°C of temperature, 45 to 85% relative humidity and 86 to 106kPa of air pressure.

When there are questions concerning measurement results:

In order to provide correlation data, the test shall be conducted under condition of 20±2°C of temperature, 45 to 85% relative humidity and 86 to 106kPa of air pressure.

Unless otherwise specified, all the tests are conducted under the "standard condition."

# PRECAUTIONS

CM04RC, BU05MC, CM01H

Stages	Precautions	Technical considerations
1.Circuit Design	<p>Operating environment,</p> <p>1.The products described in this specification are intended for use in general electronic equipment,(office supply equipment, telecommunications systems, measuring equipment, and household equipment). They are not intended for use in mission-critical equipment or systems requiring special quality and high reliability (traffic systems, safety equipment, aerospace systems, nuclear control systems and medical equipment including life-support systems,) where product failure might result in loss of life, injury or damage. For such uses, contact TAIYO YUDEN Sales Department in advance.</p>	
2.PCB Design	<p>Land pattern design</p> <p>1.Please contact any of our offices for a land pattern, and refer to a recommended land pattern of specifications.</p>	<p>Surface Mounting</p> <ul style="list-style-type: none"> <li>Mounting and soldering conditions should be checked beforehand.</li> <li>Applicable soldering process to this products is reflow soldering only.</li> </ul> <p>Recommended Land Patterns</p> <p>Unit:mm</p>
3.Considerations for automatic placement	<p>Adjustment of mounting machine</p> <p>1.Excessive impact load should not be imposed on the products when mounting onto the PC boards.</p> <p>2.Mounting and soldering conditions should be checked beforehand.</p>	<p>1. When installing products, care should be taken not to apply distortion stress as it may deform the products.</p>
4.Soldering	<p>Reflow soldering</p> <p>1.Please contact any of our offices for a reflow soldering, and refer to the recommended condition specified.</p> <p>2.This products is reflow soldering only.</p> <p>3.SMD Inductors</p> <p>Please do not add any stress to a product until it returns in normal temperature after reflow soldering.</p> <p>Lead free soldering</p> <p>1.When using products with lead free soldering, we request to use them after confirming of adhesion, temperature of resistance to soldering heat, soldering etc sufficiently.</p> <p>[CM04RC,BU05MC]</p> <p>Recommended conditions for using a soldering iron:</p> <ul style="list-style-type: none"> <li>Put the soldering iron on the land-pattern.</li> <li>Soldering iron's temperature - Below 350 °C</li> <li>Duration - 3 seconds or less</li> <li>The soldering iron should not directly touch the inductor.</li> </ul> <p>[CM01H]</p> <p>Please do not recommended conditions for using a soldering iron.</p>	<p>1.If products are used beyond the range of the recommended conditions, heat stresses may deform the products, and consequently degrade the reliability of the products.</p>
5.Cleaning	<p>Cleaning conditions</p> <p>1.SMD Inductors</p> <p>Please contact any of our offices for a cleaning,</p>	
6.Handling	<p>Handling</p> <p>1.Keep the product away from all magnets and magnetic objects.</p> <p>Breakaway PC boards (splitting along perforations)</p> <p>1.When splitting the PC board after mounting product, care should be taken not to give any stresses of deflection or twisting to the board.</p> <p>2.Board separation should not be done manually, but by using the appropriate devices.</p> <p>Mechanical considerations</p> <p>1.Please do not give the product any excessive mechanical shocks.</p> <p>2.SMD Inductors</p> <p>Please do not add any shock and power to a product in transportation.</p> <p>Pick-up pressure</p> <p>1.SMD Inductors</p> <p>Please do not push to add any pressure to a winding part.</p> <p>Please do not give any shock and push into a ferrite core exposure part.</p> <p>Packing</p> <p>1.SMD Inductors</p> <p>Please avoid accumulation of a packing box as much as possible.</p>	<p>1.There is a case that a characteristic varies with magnetic influence.</p> <p>1.Planning pattern configurations and the position of products should be carefully performed to minimize stress.</p> <p>1.There is a case to be damaged by a mechanical shock.</p> <p>2.SMD Inductors</p> <p>There is a case to be broken by the handling in transportation.</p> <p>1.SMD Inductors</p> <p>Damage and a characteristic can vary with an excessive shock or stress.</p> <p>1.There is a case that transformation and a product of tape are damaged by accumulation of a packing box.</p>
7.Storage conditions	<p>Storage</p> <p>1.To maintain the solderability of terminal electrodes and to keep the packing material in good condition, temperature and humidity in the storage area should be controlled..</p> <p>Recommended conditions</p> <ul style="list-style-type: none"> <li>Ambient temperature 0~40°C</li> <li>Humidity Below 70% RH</li> </ul> <p>The ambient temperature must be kept below 30°C. Even under ideal storage conditions, solderability of products electrodes may decrease as time passes. For this reason, product should be used within one year from the time of delivery.</p> <p>In case of storage over 6 months, solderability shall be checked before actual usage.</p>	<p>1.Under a high temperature and humidity environment, problems such as reduced solderability caused by oxidation of terminal electrodes and deterioration oftaping/packaging materials may take place.</p>